



Propagation, Dispersion and Measurement of sub-10 fs Pulses

Table of Contents

1. [Theory](#)
2. [Pulse propagation through various materials](#)
 - [Calculating the index of refraction](#)
 - Glass materials
 - Air
 - Index of refraction in the 600 -1100 nm range
 - Example: Broadening of a 7 fs pulse through different materials
 - [Group delay, group velocity and group velocity dispersion](#)
 - Group velocity
 - Group velocity dispersion
 - Group Delay for various materials
 - Example: Output pulse duration as a function of GDD
 - [Pulse broadening and distortion due to TOD](#)
 - Example: output pulse duration as a function of TOD
 - Example: Output pulse shape for SF10
 - TOD dispersion curve for various materials
 - [Pulse broadening and distortion due to FOD and higher](#)
 - [Summary of pulse broadening effects in various materials](#)
3. [Choosing the proper optics](#)
 - Some practical tips
4. [Appendix A: Pulse duration measurement](#)
5. [Appendix B: Refractive index for various materials referenced in this work](#)

Any ultrafast laser pulse is fully defined by its intensity and phase, either in time or frequency domain. Propagation in any media, inclusive of air, results in distortions of phase or amplitude. Large distortions in phase can be introduced by propagation of the beam even through optical elements with very low absorption such as lenses or prisms. This effect is frequently called temporal chirp and is due to chromatic (i.e. wavelength-dependent) dispersion.

Depending on their exact nature, phase distortions may broaden the pulse and modify its shape such that the pulse is not “transform- limited” anymore.

This means that the time-bandwidth relationship $\Delta t \Delta \nu \leq \kappa$ is not satisfied. Here κ depends on the shape of the spectrum ($\kappa = 0.441$ for a Gaussian pulse, $\kappa = 0.315$ for a hyperbolic secant pulse and $\kappa = 0.886$ for a square pulse).

1. Theory

Here for simplicity we will assume pulses with a temporal Gaussian shape. While this is only a convenient approximation it still gives a good idea of what is happening.

The electric field is defined by the expression

$$E(t) = E_o e^{-i\omega_o t} e^{-(1+ia)\left(\frac{t}{\tau_G}\right)^2}$$

With $\omega_o = \frac{2\pi c}{\lambda_o}$, where λ_o is the center wavelength (in our case 800 nm).

a is defined as the chirp parameter of the pulse and we will start without chirp so that $a=0$.

With τ_G defined as $\tau_p = \sqrt{2\ln(2)}\tau_G$, τ_p being the FWHM pulse duration.

The expression for the pulse then becomes

$$E(t) = E_o e^{i\left(-\omega_o t - \left(\frac{t}{\tau_G}\right)^2\right)}$$

A wave equation can be derived for the electric field E from the Maxwell equations (in absence of external charges and currents, and considering only non-magnetic permeability and uniform medium).

In Cartesian coordinates the equation is

$$\left(\frac{\partial^2}{\partial x^2} + \frac{\partial^2}{\partial y^2} + \frac{\partial^2}{\partial z^2} - \frac{1}{c^2} \frac{\partial^2}{\partial t^2}\right) E(x, y, z, t) = \mu_0 \frac{\partial}{\partial t^2} P(x, y, z, t)$$

With μ_0 the magnetic permeability of free space

The Polarization P contains two terms, $P = P^L + P^{NL}$, i.e. the linear and non-linear term respectively. Assuming very weakly focused pulses (with no substantial changes in the x and y direction) we can neglect P^{NL} .

We then obtain the reduced wave equation

$$\left(\frac{\partial^2}{\partial z^2} - \frac{1}{c^2} \frac{\partial^2}{\partial t^2}\right) E(z, t) = \mu_0 \frac{\partial}{\partial t^2} P^L(z, t)$$

From classic electrodynamics we know that $P^L(z, t) = \epsilon_0 \chi(\omega) E(z, \omega)$

With χ the dielectric permissibility

By combining the two previous equations and moving into the frequency domain by Fourier transform we get:

$$\left(\frac{\partial^2}{\partial z^2} + \frac{\omega^2}{c^2} \frac{\partial^2}{\partial t^2} \epsilon(\omega)\right) E(z, \omega) = 0$$

With $\epsilon(\omega) = 1 + \chi(\omega)$ the dielectric constant We assume the susceptibility and dielectric constant here are real (i.e. there is no absorption).

A general solution for the previous equation is

$$E(\omega, z) = E(\omega, 0) e^{-ik(\omega)z}$$

Where the propagation constant k is determined by the linear optics dispersion relation

$$k^2(\omega) = \frac{\omega^2}{c^2} \epsilon(\omega) = \frac{\omega^2}{c^2} n^2(\omega)$$

n being the refractive index.

The main reason to work in the frequency domain is that phases are additive, unlike in the time domain.

2. Pulse Propagation Through Various Materials

Let's continue to assume a Gaussian pulse initially chirp-free (transform limited) with a 800 nm center wavelength. To calculate the pulse envelope we need to Fourier-transform the electric field into the frequency domain, add the frequency-dependent phase, Fourier-transform back in the time domain and calculate the norm of $E(t,z)$. To summarize, the propagated field in the frequency domain is given by

$$E(\omega, z) = E(\omega, 0) e^{-ik(\omega)z}$$

We then go back in the time domain in order to calculate the envelope and duration of the output pulse.

As a first step we need to determine the index of refraction of the different materials we will consider. Then we calculate the pulse duration after propagation through 5 mm and 10 mm of material starting with a

chirp-free 7 fs input pulse. This is representative of the typical pulse produced by the Coherent Vitara UBB Ti:Sapphire laser.

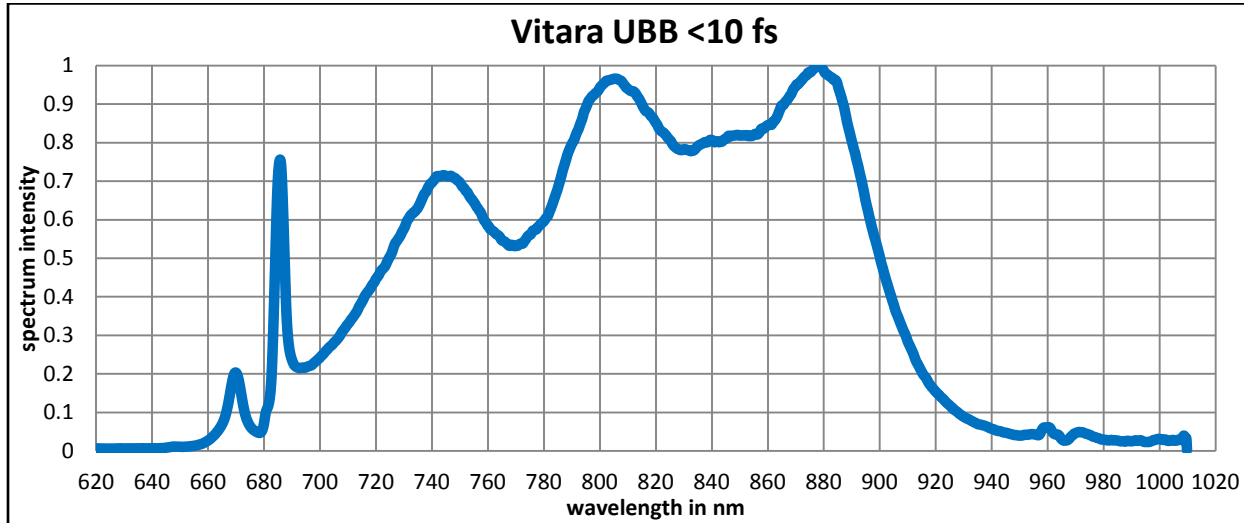

Typical spectral amplitude of pulse from Vitara UBB (Transform-limited pulse duration = 7 fs)

We are going to consider 6 media, including the most common types of glass used for laser optics, a very low dispersion material (CaF2), a high dispersion material (SF10) and finally air.

- Fused Silica
- Sapphire
- CaF2
- SF10
- BK7
- Air

Calculating the index of refraction

- Glass materials

For all glass materials, we use the well-known Sellmeier equation:

$$n^2(\lambda) = 1 + \frac{B_1\lambda^2}{\lambda^2 - C_1} + \frac{B_2\lambda^2}{\lambda^2 - C_2} + \frac{B_3\lambda^2}{\lambda^2 - C_3}$$

with λ in μm . The B and C coefficients are given in the table below.

Material	1 B1	2 B2	3 B3	4 C1	5 C2	6 C3
Fused Silica	0.6961663	0.4079426	0.8974794	0.00467914826	0.0135120631	97.9340025
Sapphire	1.43134930	0.650547130	5.34140210	0.00527992610	0.0142382647	325.017834
CaF2	0.5675888	0.4710914	3.8484723	0.00252642999	0.0100783328	1200.555973
SF10	1.62153902	0.256287842	1.64447552	0.0122241457	0.0595736775	147.468793
BK7	1.03961212	0.231792344	1.01046945	0.00600069867	0.0200179144	103.560653

Air (Edlen Model)

An accurate calculation of the refractive index of air requires a set of ten constants, in addition to its dependence on temperature, pressure and humidity

- Temperature
- Pressure
- Humidity

The ten constants for air are given in the table below.

K1	K2	K3	K4	K5
1.167052145280E+03	-7.242131670320E+03	-1.707384694010E+01	1.202082470250E+04	-3.232555032230E+06
K6	K7	K8	K9	K10
1.491510861350E+01	-4.823265736160E+03	4.051134054210E+05	-2.23855575678E-01	6.501753484448E+02

There are also five coefficients that depend on the temperature (expressed in K)

Ω_a	C_a	A_a	B_a	X_a
$\Omega_a = T + \frac{K_9}{T - K_{10}}$	$C_a = K_6\Omega_a^2 + K_7\Omega_a + K_8$	$A_a = \Omega_a^2 + K_1\Omega_a + K_2$	$B_a = K_3\Omega_a^2 + K_4\Omega_a + K_5$	$X_a = -B_a + \sqrt{B_a^2 - 4A_aC_a}$

We also need to include:

- Pressure vapor saturation :

$$P_{sv} = 10^6 \left(2 \frac{C_a}{X_a} \right)^4$$

- Partial vapor humidity :

$$P_v = \left(\frac{RH}{100} \right) P_{sv}$$

Where RH is the relative humidity and the pressure is expressed in Pascal (101325 Pa = 1 atm).

- Finally, there are seven additional constants :

A_b	B_b	C_b	D_b	E_b	F_b	G_b
8342.54	2406147	15998	96095.43	0.601	0.00972	0.003661

- We can then calculate the coefficient X_b

$$X_b = \frac{(1 + 10^{-8}(E_b - F_b(T - 273.15)))P}{1 + G_b(T - 273.15)}$$

Armed with these parameters, we calculate an expression for n_s

$$n_s(\lambda) = 1 + \left[\left(\frac{C_b}{38.9 - \frac{1}{\lambda^2}} \right) + A_b + \left(\frac{B_b}{130 - \frac{1}{\lambda^2}} \right) \right] 10^{-8}$$

that we can use to calculate the full refractive index of air

$$n_{air}(\lambda) = 1 + P(n_s(\lambda) - 1) \frac{X_b}{D_b} - 10^{-10} \left(\frac{292.75}{T} \right) \left[3.7345 - \frac{0.0401}{\lambda^2} \right] P_v$$

Index of Refraction in the 600 nm to 1100 nm Range

By applying the previous formula for air and the different materials, we get the index of refraction curve from 600 nm to 1100 nm.

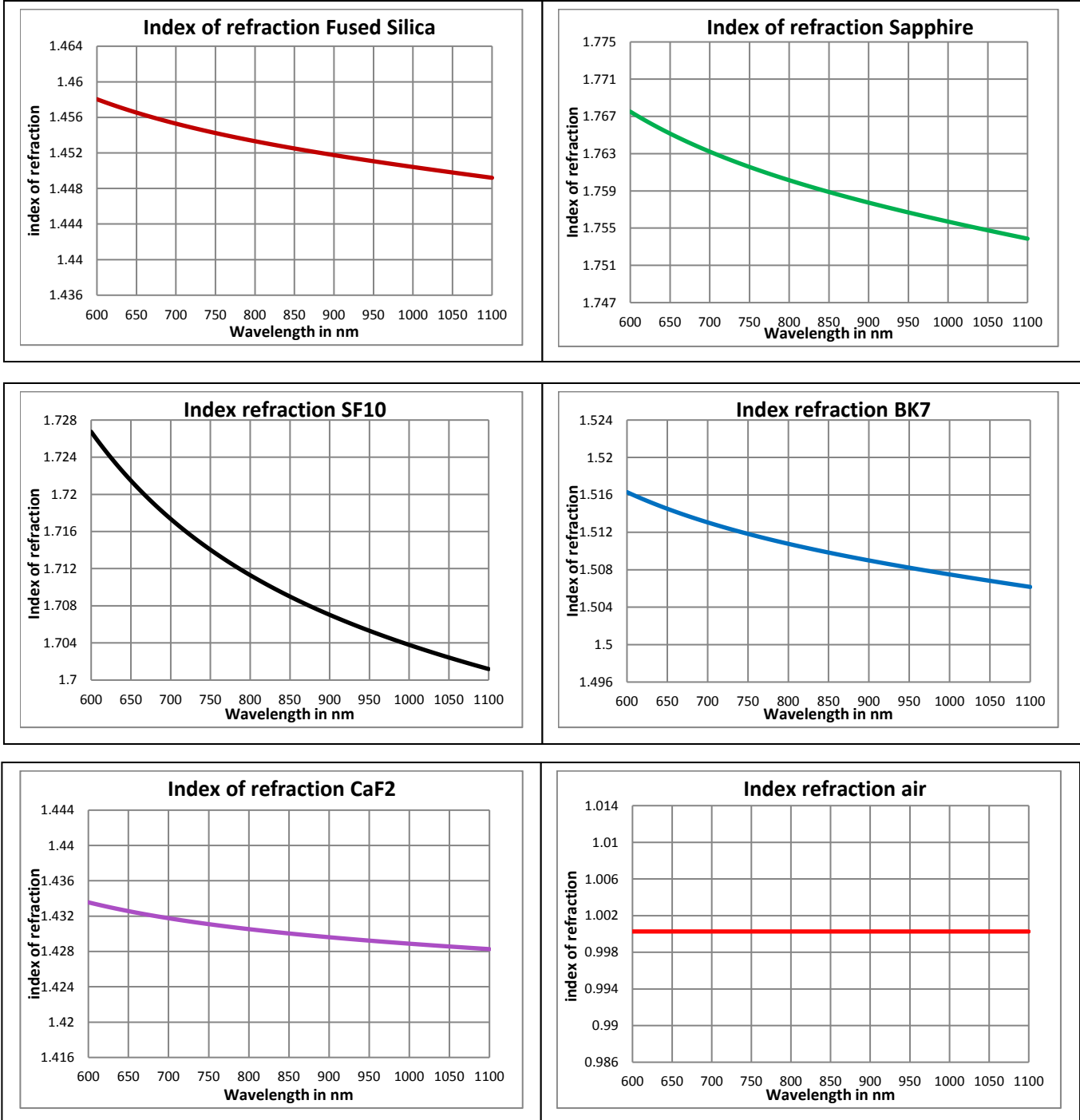

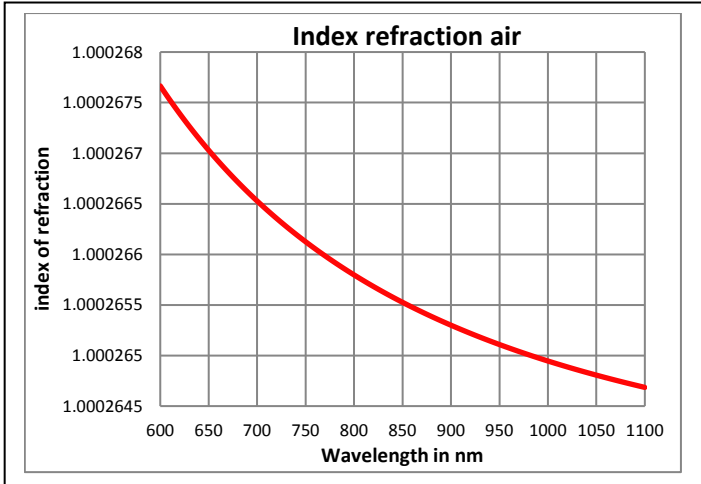

Refractive index of air on a much expanded scale shows its wavelength dependence for given temperature, pressure and humidity

The refractive indices of all materials are generally wavelength-dependent which means that each wavelength will propagate at a different speed resulting in pulse broadening of the output pulse.

The degree of broadening depends both on the change of the refractive index vs. wavelength and the initial bandwidth of the pulse.

Example: Broadening of a 7 fs Pulse through Different Materials

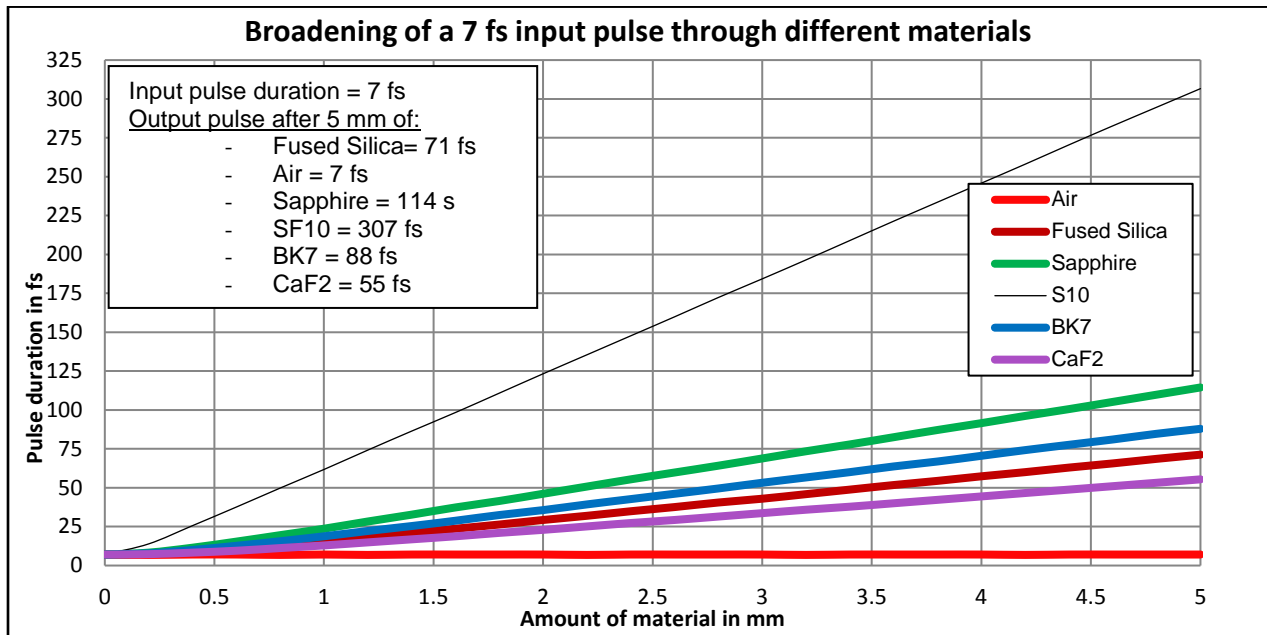

Depending on the material, pulse broadening can be minimal (in air) or dramatic (SF10) in as little as 5 mm of material. The k vectors (i.e. the combination of the three Cartesian components $n\omega/c$) are a good starting point to calculate how a pulse propagates through a

medium. Even if k (and n) doesn't change rapidly with the wavelength, this change will be much more visible in the derivatives.

Group Delay, Group Velocity and Group Velocity Dispersion

Let’s start with the Taylor expansion of the k vector to look at the different contributing factors:

$$k(\omega) = k_0 + \frac{\partial k}{\partial \omega} (\omega - \omega_0) + \frac{1}{2} \frac{\partial^2 k}{\partial \omega^2} (\omega - \omega_0)^2 + \frac{1}{6} \frac{\partial^3 k}{\partial \omega^3} (\omega - \omega_0)^3 + \frac{1}{24} \frac{\partial^4 k}{\partial \omega^4} (\omega - \omega_0)^4 + \dots$$

Group Velocity

The group velocity is defined as the velocity as which the pulse envelope travels

$$v_g = \frac{1}{\frac{dk}{d\omega}}$$

With $k = \frac{n(\omega)\omega}{c}$

This leads to:

$$v_g = \frac{c}{\left(n + \omega \frac{dn}{d\omega}\right)} = \frac{\frac{c}{n}}{1 + \frac{\omega}{n} \frac{dn}{d\omega}} = \frac{\left(\frac{c}{n}\right)}{\left(1 - \frac{\lambda}{n} \frac{dn}{d\lambda}\right)}$$

With $\lambda = \frac{2\pi c}{\omega}$

The first order derivative of k is therefore just a delay in time: the pulse propagates more slowly in a medium than in vacuum.

Group Velocity Dispersion

The Group Velocity Dispersion is defined as the second derivative of k with ω and is expressed in fs²/cm

$$GVD = k''(\omega) = \frac{d}{d\omega} \left(\frac{1}{v_g} \right) = \frac{d^2 k}{d\omega^2} = \frac{\lambda^3}{2\pi c^2} \frac{d^2 n}{d\lambda^2}$$

The Group Delay Dispersion (GDD) is simply the product of the GVD and the propagation distance:

GDD= $k''(\omega)L$ (L amount of material in cm)

The GDD is expressed in fs².

Group Delay Dispersion for Various Materials:

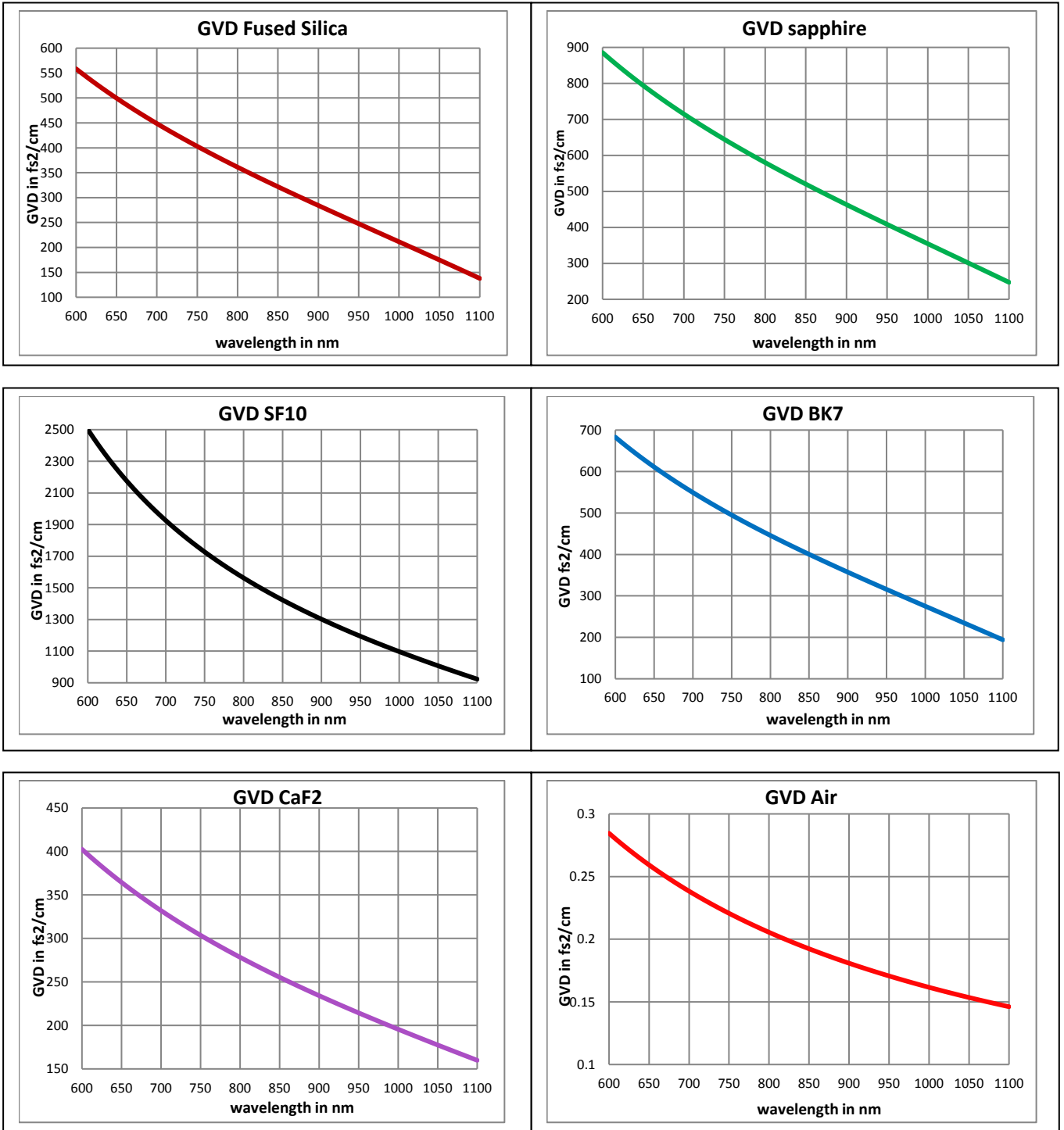

Air has the lowest GVD: 0.21 fs²/cm. After 1 meter of propagation in air the GDD at 800 nm is 21 fs²

Example: Output Pulse Duration as a Function of GDD:

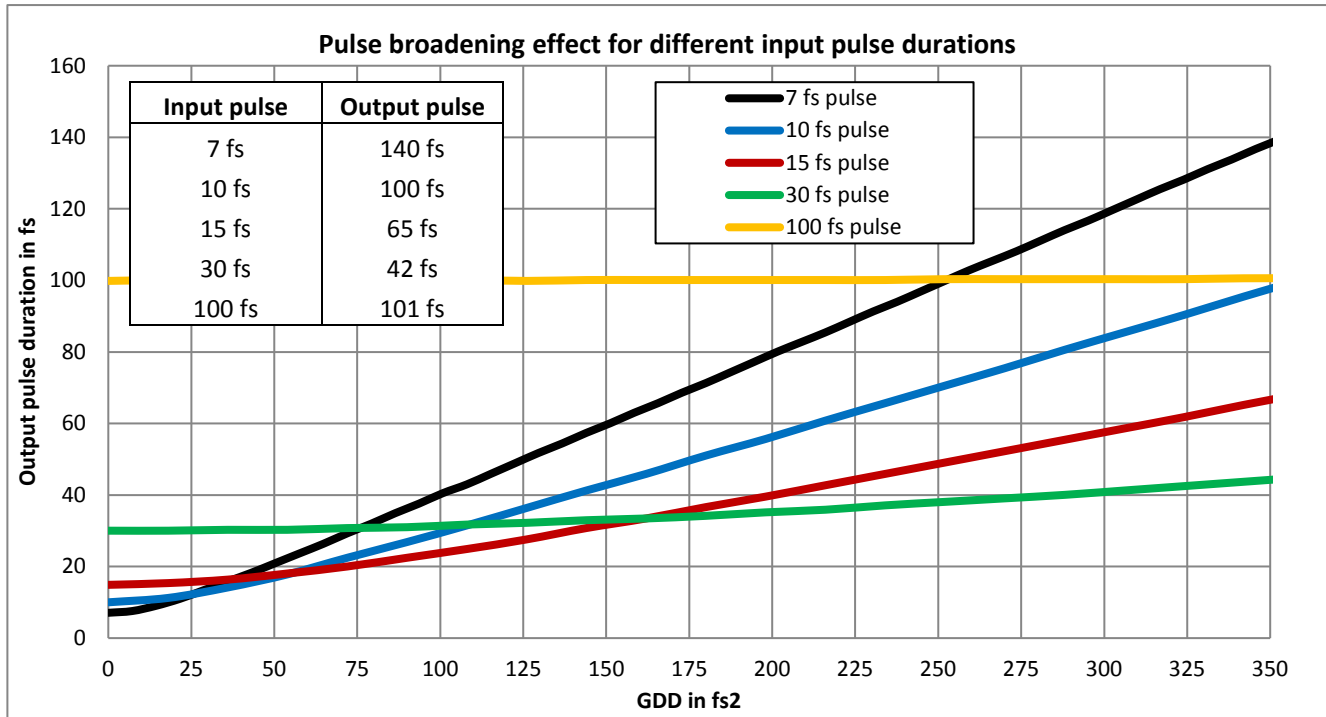

The shorter the pulse the broader the bandwidth thus, the pulse broadening is due to dispersion.

Pulse Broadening and Distortion Due To TOD

To discuss the effects of higher order terms, let's now assume that we can fully compensate the GVD.

The Taylor expansion yields the formula:

$$k(\omega) = k_0 + \frac{\partial k}{\partial \omega}(\omega - \omega_0) + \frac{1}{2} \frac{\partial^2 k}{\partial \omega^2}(\omega - \omega_0)^2 + \frac{1}{6} \frac{\partial^3 k}{\partial \omega^3}(\omega - \omega_0)^3 + \frac{1}{24} \frac{\partial^4 k}{\partial \omega^4}(\omega - \omega_0)^4 + \dots$$

In order to determine the effects of high order dispersion first focus on the TOD by removing the first terms in the Taylor expansion

$$(k(\omega_0) + \frac{\partial k}{\partial \omega}(\omega - \omega_0) + \frac{1}{2} \frac{\partial^2 k}{\partial \omega^2}(\omega - \omega_0)^2).$$

These terms represent respectively a constant, a fixed delay and the GVD.

We can then rewrite the k vector as:

$$k_{sub(\omega)} = k(\omega) - k(\omega_0) - \frac{\partial k}{\partial \omega}(\omega - \omega_0) + \frac{1}{2} \frac{\partial^2 k}{\partial \omega^2}(\omega - \omega_0)^2$$

And we finally end up with the following propagation equation:

$$E(\omega, z) = E(\omega, 0)e^{-ik_{sub(\omega)}z}$$

The TOD is defined at the third derivative of the k vector:

$$TOD = \frac{d^3 k}{d\omega^3} = k'''(\omega) = -\left(\frac{\lambda}{2\pi c}\right)^2 \frac{1}{c} \left(3\lambda^2 \frac{d^2 n}{d\lambda^2} + \lambda^3 \frac{d^3 n}{d\lambda^3}\right)$$

Example: Output Pulse Duration as a Function of TOD

The pulse broadening due to TOD for different materials is shown below.

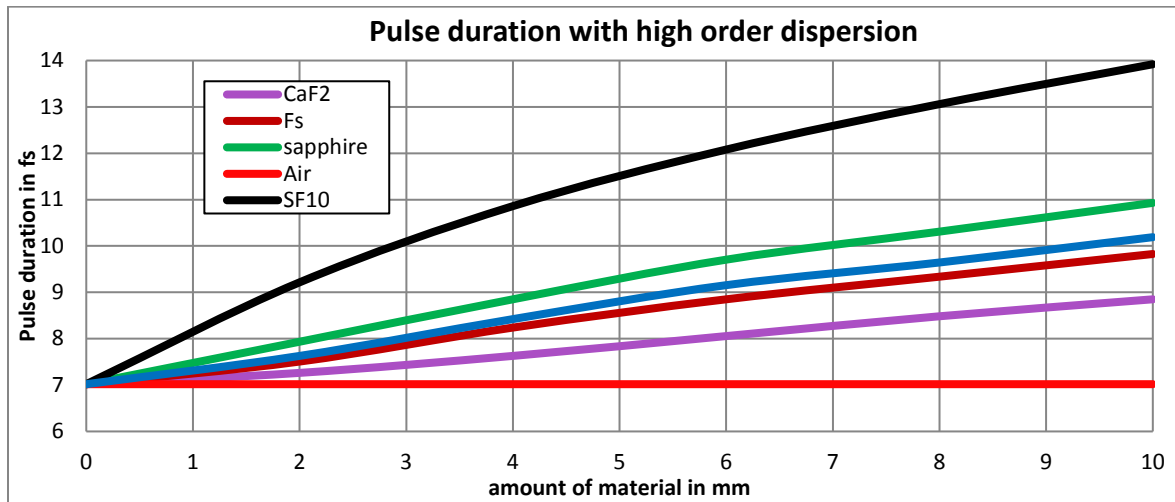

The pulse broadening due to TOD is much lower than the GVD term (20 times) but the output pulse experiences some distortion as we can see after just 5 mm of SF10 knowing all the GDD has been perfectly compensated for here.

Example: Output Pulse Shape for SF10

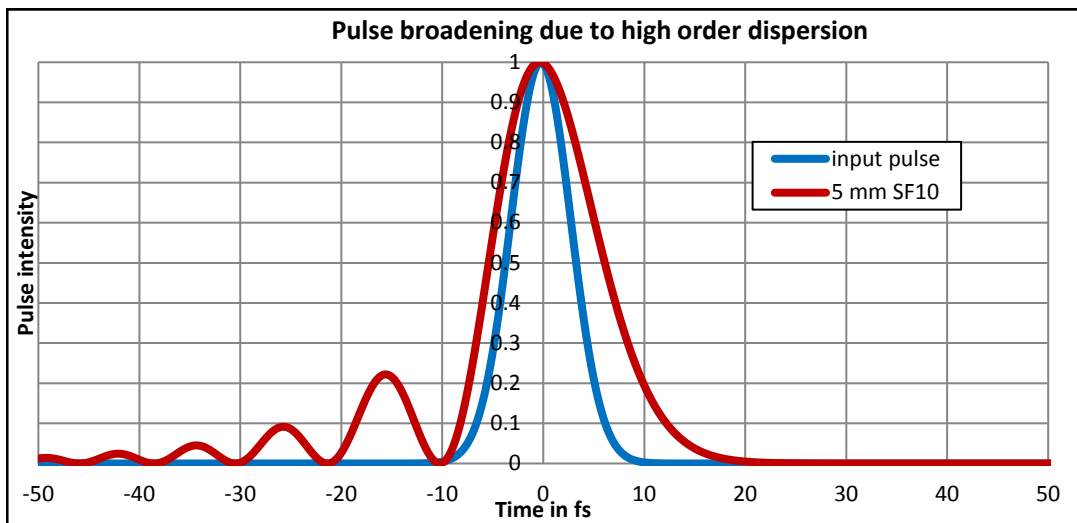

Even if the pulse broadening is not dramatic (we go here from 7 fs to 11 fs), the pulse shape degrades considerably as multiple side pulses may negatively affect some experiments.

TOD Dispersion Curve for Various Materials

TOD for Various Materials

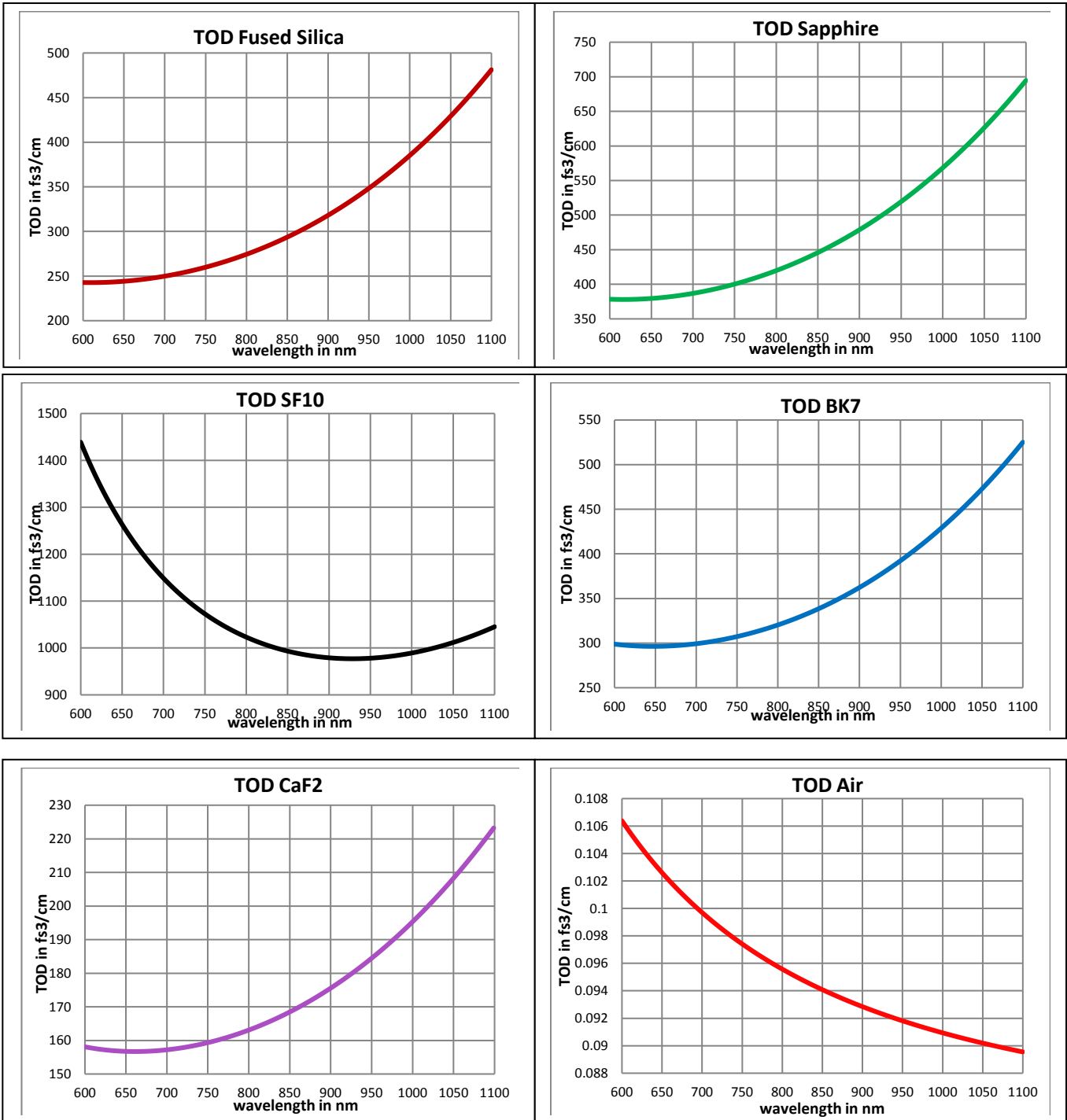

Output Pulse as a Function of TOD for Multiple Input Pulse Durations

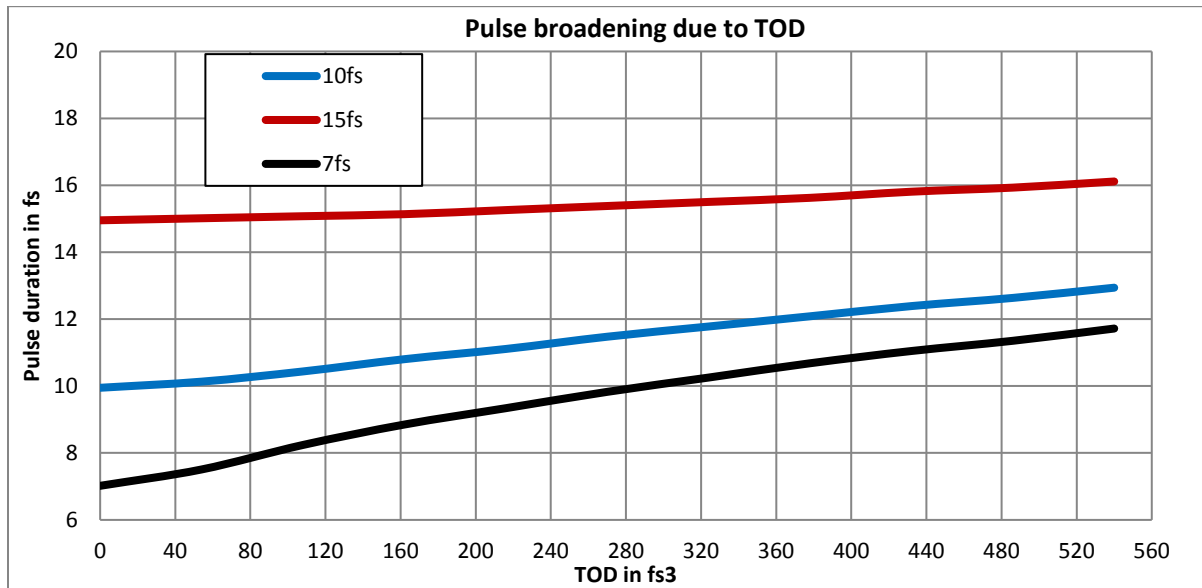

Like in the case of GDD, longer pulses (with narrower bandwidth) are less sensitive to the third order dispersion term.

A Very Short Pulse Propagating Through Fused Silica Glass of Various Thicknesses
 the TOD of Fused Silica Is 274 Fs³/Cm

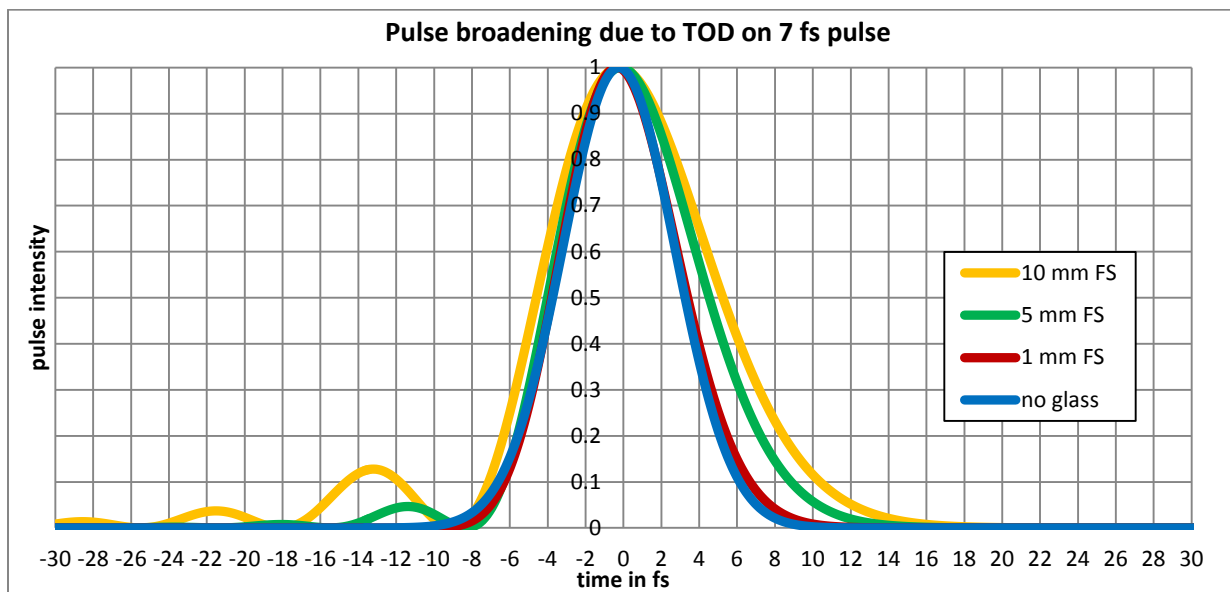

Fused Silica is the most commonly used glass material, together with BK7. Even if the pulse broadening is just a few femtoseconds (from 7 to 10 fs) the pulse shape becomes so distorted that compensation for TOD

becomes almost mandatory for many applications involving very short pulses. This can be accomplished by introducing so-called Negative Dispersion Mirrors (NDM) designed for TOD (and GVD) compensation.

Pulse Broadening and Distortion Due FOD and Higher Order Dispersion

Let's now assume perfect compensation for GDD and TOD: this means that the fourth order is the next most significant residual contribution. As shown in the

simulation below, after 10 mm propagation in Fused Silica the pulse broadens to 7.3 fs. Also, after a 50 mm of Fused Silica, the output pulse duration becomes 8 fs with very low distortion in the pulse shape. This means that even for a 7 fs pulse, we don't really need to compensate for FOD and higher order dispersion.

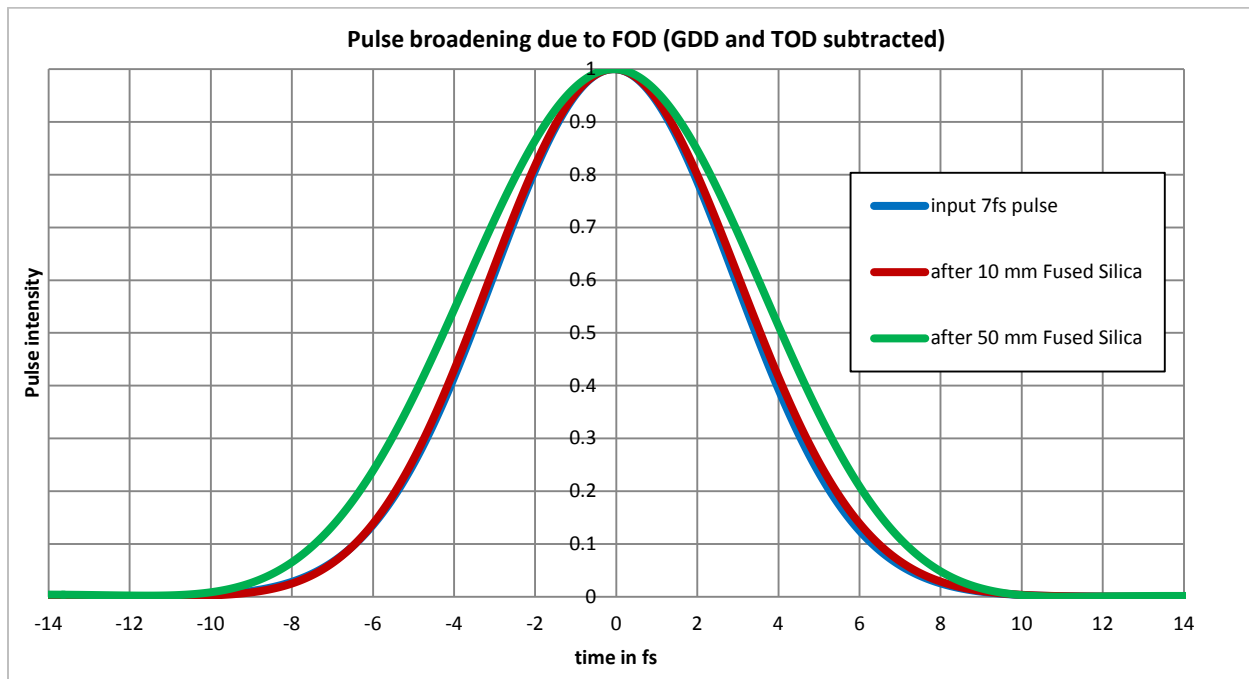

Summary of Pulse Broadening Effects in Various Materials

Ultra broad band lasers generating extremely short pulses (like Vitara UBB) are subject to strong pulse broadening because of the dispersive effects taking place during propagation in any material.

A simple 1 millimeter thick **fused silica plate will double the output pulse duration of the laser** (from 7 to 15 fs) and considering that a typical lens has a thickness of at least 3-4mm, GDD compensation is required in order to maintain the original pulse duration. Even propagation in one meter of air stretches the pulse to 10 fs.

Ideally one should use low dispersion glass like CaF_2 but this is not always readily available. Fused Silica and BK7 are acceptable choices but high GVD materials like SF10 have to be avoided. A good rule of

thumb is to stay away from materials with a GVD of more than $500\text{fs}^2/\text{cm}$.

GVD can be compensated by a prism pair or negative dispersion mirrors but this is not enough for such ultrashort pulses as they will still suffer great distortions (side pulses and ripples) due to higher order dispersion like TOD. TOD can be compensated by using appropriate combination of prism materials and separation in a prism compressor. This may take quite some space on an optical set-up and it may be hard not to optically clip the beam with some optics.

TOD can also be compensated by using NDMs with TOD compensation included in their coating design.

The main idea is still to limit the use of transmission optics as much as possible to reduce the quantity of material in the propagation path. Wherever possible, reflective optics should be used.

Choosing the proper optics

As mentioned earlier we have to limit, as much as possible, the amount of material introduced in the beam. In addition we need to make sure that any optic (reflective, transmissive or refractive) used is suited for

the laser bandwidth in terms of reflectivity and phase control.

Most of the “off-the-shelf” mirrors/ optics come with a reflectivity specification but without any specification on the dispersion. This means that the mirrors are not controlled for their GDD performance and one could unwittingly end up using an optic with a highly modulated GDD. An example of such an off-the-shelf mirror is shown below:

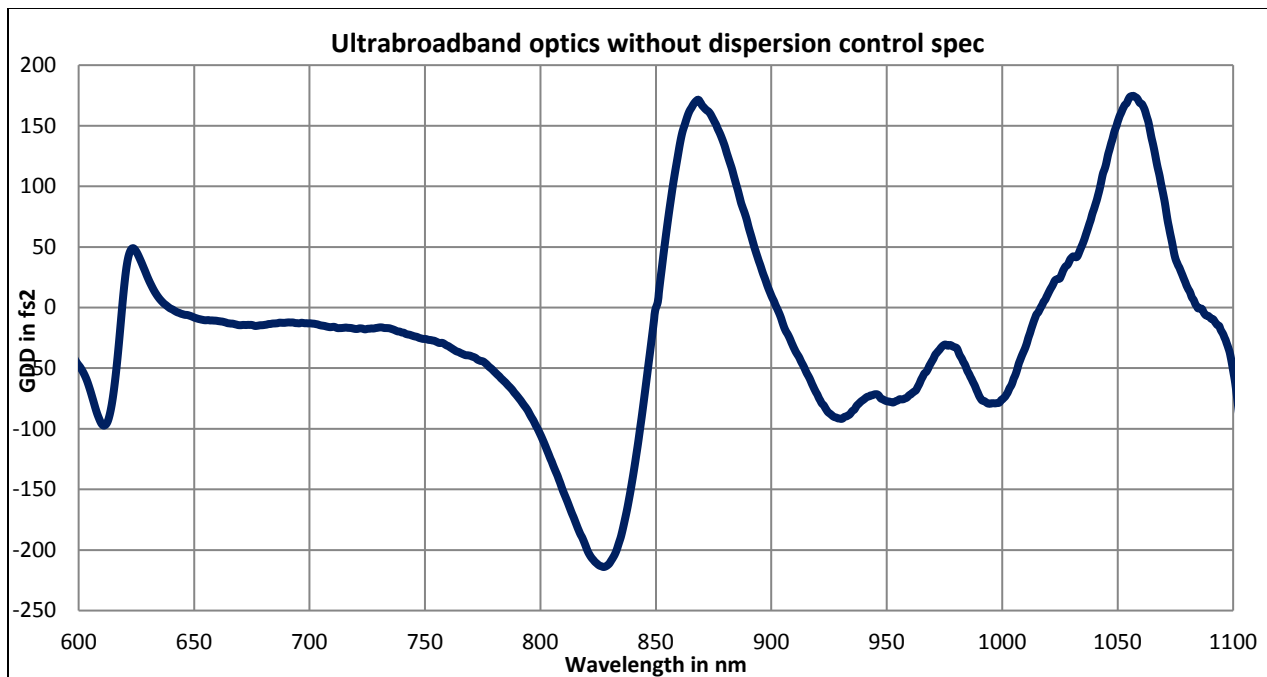

This optic displays a huge GDD jump at 820 nm and this would impart high order dispersion on the laser pulses, making very difficult to compress the pulses. Making sure that the mirrors are manufactured with controlled GDD is a better approach; however it may not be sufficient because many optics don't have a “hard” specification in terms of dispersion control.

A good rule of thumb for optical coatings is to assume that the dispersion control vanishes. (i.e. GDD becomes highly modulated) 20 nm to 30 nm

before the boundaries of the reflectivity specification (Although with some NDM designs it can be even worse).

- Example: an optic with GDD optimization and reflectivity specified between 650 nm and 950 nm is likely to have GDD control only in the region 670 nm to 930 nm.

In summary, remember that lack of GDD control will lead to pulses that cannot be compressed easily, leading to overall system degradation.

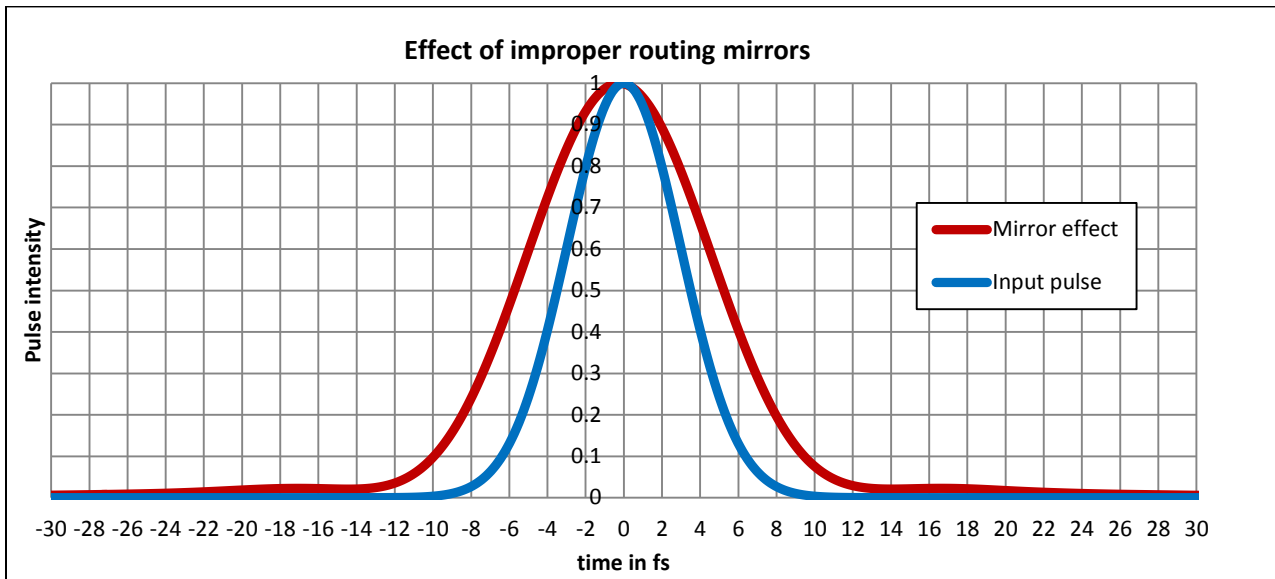

Some Practical Tips

- Check the specification of all optics for proper Reflectivity and Phase (GDD) control
- A wavelength range 600 nm to 1000 nm is recommended
- Silver mirrors have a naturally flat phase at 600 nm to 1000 nm and work reasonably well. The down-side is the relatively high 3% loss per reflection
- For transmission or refractive optics it is better to use CaF2 or BaF2 rather than Fused Silica because these fluorides introduce less TOD (and GDD in case of CaF2)
- NDMs with TOD compensation can be purchased from these vendors (not a comprehensive list):
 - Layertec (some mirrors have TOD compensation)
 - Ultrafast Innovation
 - LaserOptik

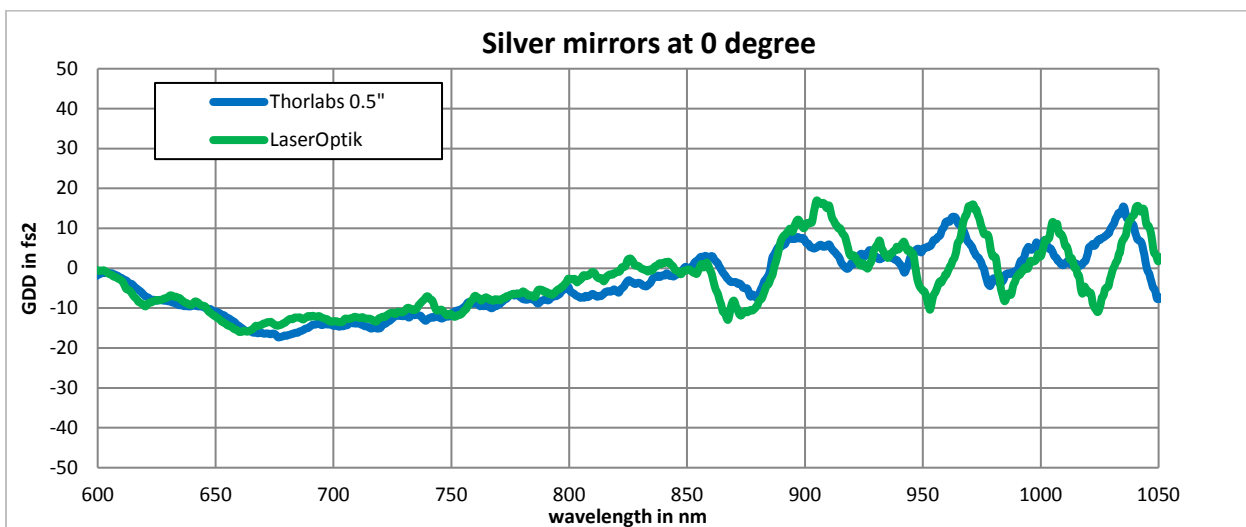

Appendix A: Pulse Duration Measurement

In order to measure properly the pulse of broadband lasers like Vitara UBB (typically 7fs Transform limit for <10 fs laser and 6 fs Transform Limit for <8 fs option) we need to use the proper pulse measurement tool.

Many devices like FROGs, autocorrelators and SPIDERS are commercially available or home-built, however not all are suitable to match the repetition rate and pulse duration of these ultra-broadband oscillators.

At Coherent we typically use an FC spider manufactured by APE (Berlin, Germany). Details can

be found at <http://www.ape-america.com/> and <http://www.ape-berlin.de/>.



Our FC Spider has the following specifications:

Wavelength range	550 nm to 1050 nm
Spectral bandwidth	> 30 nm @ 800 nm
Pulse width range (for transform limited pulses)	5 - 30 fs
Max. pulse width (for non-transform limited pulses)	< 180 fs
Input polarization	linear / horizontal
Input power	> 100 mW @ 80 MHz, 10 fs
	~ 20 mW @ 1 kHz, 20 fs

This SPIDER properly matches the Vitara UBB output (roughly 600 to 1000 nm spectrum) both in bandwidth and pulse duration ranges. Any other device that

satisfies these specification listed above should be able to measure the pulses from Vitara UBB.

Setup Example:

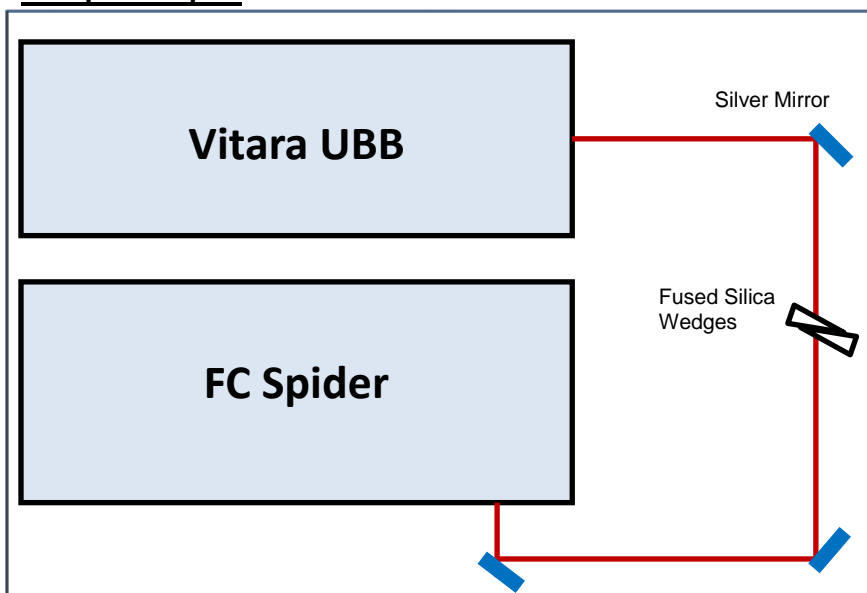

- The Vitara output is intentional slightly negatively chirped and collimated
- All the routing mirrors used are silver coated
- A pair of thin Fused Silica wedges are used for fine tuning the dispersion

The Vitara output is deliberately slightly negatively chirped so that insertion of material like a thin pair of wedges results in optimally compressed pulses.

Typical Measurements

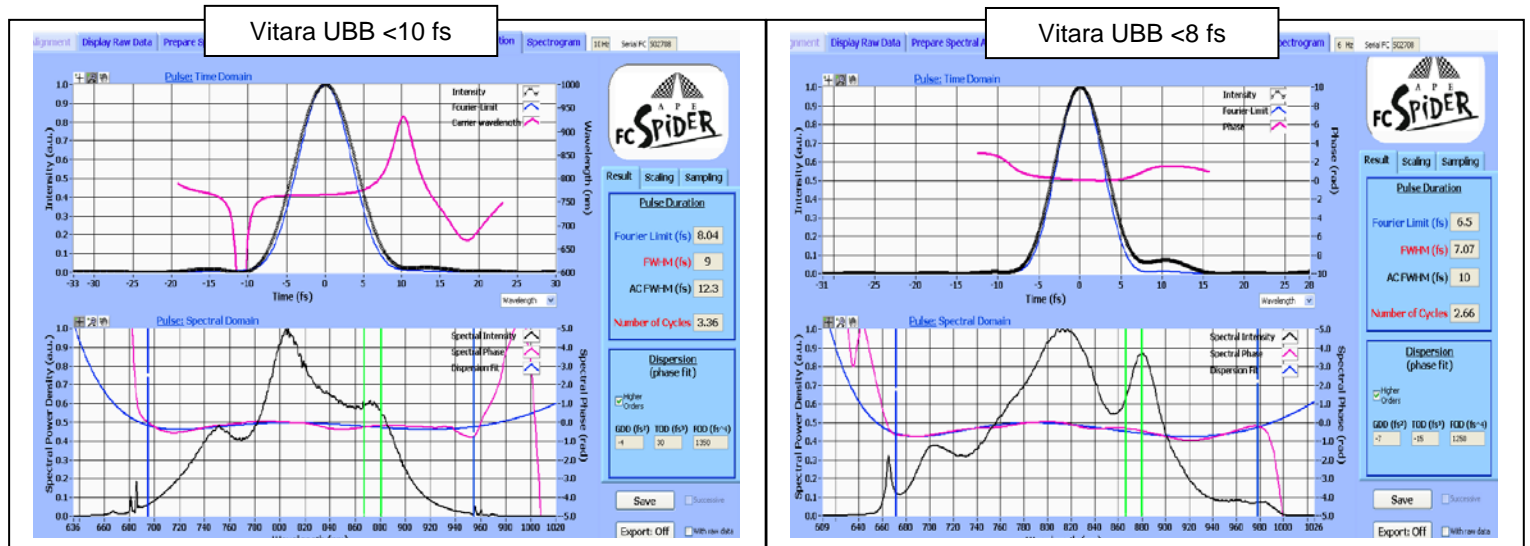

Appendix B: Refractive index, GVD and TOD of Materials Referenced in This Work

Refractive Index for Various Materials

Wavelength in nm	Index air	Index Fused Silica	Index Sapphire	Index SF10	Index BK7	Index CaF2
600	1.000267665	1.458037702	1.767511917	1.7267368	1.516294826	1.43356391
620	1.000267391	1.457399374	1.766511098	1.724468692	1.515539496	1.433138677
640	1.000267144	1.456811819	1.765590848	1.722425098	1.514846238	1.432750201
660	1.000266919	1.456268423	1.76474073	1.72057469	1.514206968	1.432393848
680	1.000266714	1.455763571	1.763951884	1.718891503	1.513614834	1.432065679
700	1.000266527	1.455292466	1.763216745	1.717353849	1.513063997	1.431762329
720	1.000266356	1.454850998	1.762528822	1.715943473	1.512549454	1.431480908
740	1.000266198	1.454435619	1.761882518	1.71464491	1.512066895	1.431218923
760	1.000266054	1.454043259	1.761272989	1.713444974	1.511612594	1.430974211
780	1.00026592	1.453671248	1.76069602	1.712332362	1.511183314	1.430744893
800	1.000265797	1.453317255	1.760147931	1.711297333	1.510776231	1.430529326
820	1.000265682	1.452979236	1.7596255	1.710331449	1.510388873	1.430326071
840	1.000265576	1.452655394	1.759125891	1.709427371	1.510019065	1.430133861
860	1.000265477	1.452344143	1.758646603	1.708578687	1.509664892	1.429951577
880	1.000265385	1.452044079	1.758185422	1.707779772	1.509324659	1.42977823
900	1.000265299	1.451753955	1.757740382	1.707025675	1.508996862	1.42961294

Table continued on following page.

Wavelength in nm	Index air	Index Fused Silica	Index Sapphire	Index SF10	Index BK7	Index CaF2
920	1.000265219	1.45147266	1.757309734	1.706312022	1.508680161	1.429454925
940	1.000265144	1.451199203	1.756891915	1.705634936	1.508373361	1.429303486
960	1.000265074	1.450932694	1.756485526	1.70499097	1.508075392	1.429157997
980	1.000265008	1.450672335	1.756089312	1.70437705	1.507785294	1.429017896
1000	1.000264946	1.450417409	1.755702144	1.703790426	1.507502204	1.428882679
1020	1.000264887	1.450167268	1.755323004	1.703228634	1.507225343	1.42875189
1040	1.000264832	1.449921325	1.754950973	1.702689457	1.506954006	1.428625118
1060	1.00026478	1.449679048	1.754585218	1.702170901	1.506687557	1.428501989
1080	1.000264731	1.449439956	1.754224982	1.70167116	1.506425416	1.428382167
1100	1.000264685	1.44920361	1.753869578	1.701188603	1.506167057	1.428265344

Group Velocity Dispersion (GVD) for Various Materials

Lambda	GVD Air	For 1m	GVD FS	GVD Sapphire	GVD SF10	GVD BK7	GVD CaF2
600	0.284541919	28.4541919	558.5042809	885.5458661	2501.334857	682.8855393	402.5165931
620	0.273844289	27.38442895	533.9063906	847.223361	2359.645224	652.6918433	386.5375277
640	0.263962706	26.39627058	510.810039	811.2790595	2233.737435	624.5015094	371.615626
660	0.254804168	25.48041676	489.0163788	777.4053222	2120.923681	598.0473408	357.6257754
680	0.246289569	24.62895687	468.3551213	745.3389099	2019.087827	573.1025707	344.4606449
700	0.238351178	23.83511782	448.6793267	714.8529276	1926.541093	549.4731811	332.0275537
720	0.230930597	23.09305965	429.8612935	685.7504677	1841.919133	526.9919119	320.2459824
740	0.223977263	22.39772633	411.7892878	657.8595474	1764.107379	505.5135409	309.0455774
760	0.217447086	21.74470865	394.3649146	631.0290413	1692.186017	484.9111312	298.3645384
780	0.211301474	21.13014744	377.5009917	605.1253892	1625.388861	465.0730189	288.1483051
800	0.205506488	20.55064879	361.1198138	580.029909	1563.072192	445.900377	278.3484802
820	0.200032132	20.00321324	345.1517285	555.6365896	1504.690885	427.3052305	268.9219399
840	0.194851802	19.4851802	329.5339572	531.8502667	1449.779898	409.2088258	259.8300963
860	0.189941823	18.99418234	314.2096154	508.5851041	1397.939775	391.540284	251.0382795
880	0.185281038	18.52810385	299.1268921	485.7633234	1348.825191	374.2354811	242.5152196
900	0.180850486	18.08504863	284.2383594	463.3141355	1302.135817	357.2361107	234.2326092
920	0.176633101	17.66331009	269.5003885	441.1728368	1257.608966	340.4888962	226.1647321
940	0.172613523	17.26135235	254.8726532	419.2800407	1215.013646	323.9449241	218.2881465

Table continued on following page.

Lambda	GVD Air	For 1m	GVD FS	GVD Sapphire	GVD SF10	GVD BK7	GVD CaF2
960	0.16877782	16.87778201	240.3177055	397.581023	1174.145699	307.5590775	210.581414
980	0.165113383	16.51133825	225.8006116	376.0251589	1134.823809	291.2895525	203.0248673
1000	0.161608748	16.16087483	211.2886384	354.5654397	1096.8862	275.0974433	195.6004082
1020	0.1582535	15.82534997	196.7509806	333.1580541	1060.187897	258.9463841	188.2913346
1040	0.155038045	15.5038045	182.1585263	311.7620257	1024.598419	242.8022404	181.0821878
1060	0.15195369	15.19536898	167.4836495	290.3388967	989.9998592	226.6328394	173.9586219
1080	0.148992379	14.8992379	152.70003	268.852452	956.2852454	210.4077363	166.9072871
1100	0.146146805	14.61468049	137.7824951	247.268477	923.3571578	194.0980083	159.9157289

Third Order Dispersion (TOD) for Various Materials

Lambda	TOD Air	For 1m	TOD FS	TOD Sapphire	TOD SF10	TOD BK7	TOD CaF2
600	0.106386348	10.63863481	242.7751686	378.4121126	1438.677216	298.8590657	158.0843856
620	0.104746861	10.47468608	242.7925038	378.0663948	1359.136602	297.1641051	157.3116798
640	0.103280395	10.32803953	243.5323813	378.7721018	1292.564059	296.4115443	156.8535796
660	0.101962875	10.19628745	244.972147	380.4884312	1236.483009	296.5457692	156.6916164
680	0.100774283	10.07742826	247.0986525	383.1886018	1189.018494	297.5270561	156.8118907
700	0.099697908	9.969790842	249.9066424	386.857362	1148.731115	299.3285381	157.2042547
720	0.098720031	9.872003136	253.3975115	391.4890307	1114.502303	301.93388	157.8616559
740	0.097828155	9.782815525	257.5783465	397.0859963	1085.453593	305.3355441	158.7796302
760	0.0970126	9.701259993	262.4611822	403.657526	1060.888789	309.5333743	159.9558959
780	0.096264955	9.626495534	268.0624098	411.2188342	1040.251944	314.5335863	161.3900415
800	0.095577415	9.557741485	274.4023262	419.7903112	1023.096338	320.3479069	163.0832379
820	0.094943821	9.494382101	281.5047715	429.3969769	1009.061311	326.992917	165.0380665
840	0.094358419	9.435841931	289.3968386	440.067948	997.8547502	334.4895509	167.2582985
860	0.093816648	9.38166481	298.1086572	451.836077	989.2396824	342.8626725	169.7488108
880	0.093313811	9.331381075	307.6732423	464.7376487	983.0239307	352.1407537	172.5154181
900	0.092846409	9.284640876	318.1263087	478.812079	979.0520497	362.3556326	175.5648022
920	0.092411164	9.241116417	329.5062284	494.1017545	977.1989838	373.5422902	178.9044306
940	0.092005221	9.200522139	341.8539304	510.6518543	977.3650403	385.7387105	182.5424854
960	0.091625751	9.162575075	355.2128439	528.5101978	979.4718716	398.9857464	186.4877993
980	0.091270773	9.127077259	369.6288921	547.7271463	983.4592627	413.3270591	190.7498295

Table continued on following page.

Lambda	TOD Air	For 1m	TOD FS	TOD Sapphire	TOD SF10	TOD BK7	TOD CaF2
1000	0.090938161	9.093816112	385.1504491	568.3555109	989.2824871	428.8090169	195.3385786
1020	0.090625672	9.062567197	401.8283474	590.4504851	996.9102232	445.4806385	200.264623
1040	0.090332055	9.033205547	419.7158937	614.0696134	1006.322793	463.3936499	205.5390218
1060	0.090055558	9.005555769	438.8688884	639.2726809	1017.510732	482.6023691	211.1733244
1080	0.089795391	8.979539125	459.3456353	666.1217688	1030.473641	503.163791	217.1795391
1100	0.089549317	8.954931664	481.2070044	694.681162	1045.219166	525.137526	223.5701264

References:

- “*Ultrashort laser pulse phenomena*” **Jean Claude Diels, Wolfgang Rudolph**, Optics and Photonics.
- “*Pulse Propagation Through Different Materials User-Friendly Simulation Software*”, **Johan Mauritsson**, Lund Reports on Atomic Physics, LRAP-310, Lund, August 2000
- <http://www.ape-america.com/> and <http://www.ape-berlin.de/>.
- <http://emtoolbox.nist.gov/Wavelength/Documentation.asp>

Author Information:

Estelle Coadou
R & D Laser Development Engineer
Coherent, Inc.